

OWNER'S MANUAL OF

CORSIVA 650 TENDER

MOTORBOAT



Manufacturer:

Corsiva Yachting

<http://corsiva.pl/>

INDEX

1. INTRODUCTION.....	3
2. RISK ASSESSMENT.....	4
3. GENERAL SAFTY RULES.....	5
3.1. Safety.....	5
3.2. Passengers on board.....	5
3.3. Life-saving equipment.....	6
4. IDENTIFICATION OF BOAT.....	7
4.1. Craft identification number (CIN).....	7
4.2. Builder's plate.....	8
4.3. Declaration of Conformity of Recreational Craft.....	8
5. STABILITY AND BUOYANCY.....	9
6. DESCRIPTION OF BOAT.....	11
6.1. Technical data.....	11
7. ENGINE.....	12
7.1. Engine compartment.....	13
7.1.1. Gravitational ventilation.....	13
7.1.2. Mechanical ventilation.....	14
8. STEERING SYSTEM.....	15
8.1. Boat steering system.....	15
8.2. Navigation lights.....	16
8.3. Steering system.....	17
8.4. Field vision from the helm's position.....	17
9. FUEL SYSTEM.....	18
10. ELECTRICAL INSTALLATION.....	19
11. SANITARY SYSTEM.....	21
12. BILGE INSTALATION.....	22

13. BOTTOM, SIDE AND DECK OPENINGS.....	23
14. FIRE PROTECTION.....	24
15. UPHOLSTERY.....	25
15.1. Sundeck.....	26
16. MAINTENANCE, PAINTING, CLEANING.....	27
16.1. Stainless steel.....	28
17. TRAILERING AND LAUNCHING.....	29
18. ANCHORING, MOORING AND TOWING.....	30
19. ENVIRONMENTAL PROTECTION.....	31
19.1. Oil derivatives.....	31
19.2. Sewage and waste removal.....	32
20. REMOVING MALFUNCTIONS.....	32

1. INTRODUCTION

The Owner's manual, which you received together with a boat, will help you operate your CORSIVA 650 TENDER motorboat safely and appropriately so you may use it with pleasure. Manual contains the description of the boat, its equipment and installation systems as well as practical information about its use and maintenance.

Read the information carefully before using the boat.

This Owner's Manual is not a detailed guide of the boat's maintenance or troubleshooting. In case of difficulties, contact your manufacturer or its dealer.

Always employ trained and qualified people for maintenance or repairs.

Repairs which may impact on safety features of the yacht should be evaluated, carried out and documented by qualified people.

The boat manufacturer is not responsible for the modifications made without its consent, therefore, any modification of the boat repeals the boat's warranty.

Always keep your boat in a good condition and take into account the boat's deterioration that will follow in time as a result of intensive use or improper handling of the boat.

Each boat, regardless of how it is strong, can be severely damaged if is not properly used. Always adjust the speed and direction of the boat to the conditions on the water.

This owner's manual owner is not a course of safety yachting or sailing skills.

If this is your first boat or if you change the boat's type (to which you do not know) for your own comfort and safety, make sure that you got the experience in leading the boat and operating it. Your dealer, a national sailing federation or boat clubs will be pleased to provide you all information on local marine schools or qualified instructors.

**PLEASE KEEP THIS OWNER'S MANUAL
IN A SAFE PLACE
AND HAND IT OVER TO A NEW OWNER WHEN
YOU SELL THE BOAT**

With wishes of successful cruises,

Corsiva Yachting

**) We are an intensively developing company and our boats are constantly improved, therefore, some of the solutions and information included in this manual might not apply to your boat.*

2. RISK ASSESSMENT

The manual contains three kinds of sign, which are supposed to turn your attention to the actions and situations which may cause danger for health or life if they are not fulfilled.

Make sure you are familiar with the following signs:



DANGER

The sign warns before appearing the highest danger, which can cause durable damage of body or death unless the appropriate safety actions are taken.



WARNING

The sign warns before appearing the danger, which can cause durable damage of body or death unless the appropriate safety actions are taken.



CAUTION

The sign reminds about applying the safety behavior or turns attention to inappropriate behavior, which may result body injuring, the damage to the boat as well as its elements or damages to the natural environment.



A warning sign used in accordance with PN-EN ISO 11192 Graphical symbols

3. GENERAL SAFTY RULES

3.1. Safety

Even if all was planned the safety of the sailing remains heavily dependent on the weather, sea conditions, the experience and knowledge of the crew.

Always check the weather forecast before leaving and see that the circumstances should be expected to the boat's construction category.

Before you prepare your boat for sailing, check local water sailing legislations under which you have to obey.

Check the restrictions for swimming; speed limit restrictions and outboard noise and fumes reduction.

Stimulants

Never sail under the influence of alcohol or drugs.

The combination of noise, vibration, sun, wind and water movement causes fatigue. The effects of alcohol on the water are worse than on land.



WARNING

Stimulants and sailing do not go together. Operating a boat while being under the influence of alcohol or other forbidden substances is illegal and dangerous. Weakening eyesight or assessment of the situation can lead to a disaster.

3.2. Passengers on board

During boarding the passengers, stop the engine.

Moving the engine level to the neutral position is not sufficient.



WARNING

The helmsman cannot allow anyone to sit on the parts of the boat not intended for it. In particular the boat edges, seatbacks, transom, bow, or anywhere where an unexpected acceleration or sudden stop will cause a person fall overboard.

The boat's helmsman is responsible for passengers and cargo.

Do not overload the boat.

The boat is evaluated relatively to the maximum of load and capacity.

If in doubt, contact your dealer or the yacht manufacturer.



WARNING

Always turn off the engine when the boat is located near people in the water.
Even at low engine power, the screw can cause serious injuries.

3.3. Life-saving equipment

There should be a boat type and weather conditions' appropriate safety equipment on the boat (life jackets, safety harnesses, etc.) In some countries equipment is indicated and required by the local law.

Carefully read the manual of a life raft.

The crew should be familiar with the use of all safety equipment and emergency maneuvering (man overboard, towing, etc.). Sailing schools and clubs regularly organize training sessions.



WARNING

Read carefully the instructions placed on the life jackets label and follow them.
Checking the condition of life jackets, make sure it fits the body.
Try vest before you fall into the water.

All persons should wear appropriate rescue measures (lifejackets / buoyancy aids), while they are on board. Please note that in some countries there is a legal requirement to wear a permanent rescue equipment.



WARNING

It is important for children and non-swimmers to wear life jackets. Children who cannot swim require special instruction on how to use lifejackets.

4. IDENTIFICATION OF BOAT

The CORSIVA 650 TENDER boat was manufactured by CORSIVA according to applicable requirements of Annex I to Directive 2013/53/UE of European Parliament and the European Council, Recreational craft and personal watercraft.

The CORSIVA 650 TENDER boat was tested by Polish Register of Shipping according with applicable requirements of Annex I to Recreational Craft Directive 2013/53/UE for design category C.

The design category C - INSHORE defines the craft which has been designed for sailing at typical wind force Beaufort Force 6° and significant wave heights up to and including to 2 meters.

Such conditions may be encountered on open inland waters, estuaries and coastal waters in moderate weather conditions.

4.1. Craft identification number (CIN)

The CORSIVA 650 TENDER can be identified by the same identification number plates located in two places on the boat.

First one is placed on the right side of a transom, the second one is hidden inside the construction of boat in a place only known to its manufacturer. CIN is needed to identify a boat in case it was stolen.



P	L	-	C	O	R	6	5	T	0	5	C	0	2	0
---	---	---	---	---	---	---	---	---	---	---	---	---	---	---

The craft identifications number includes:



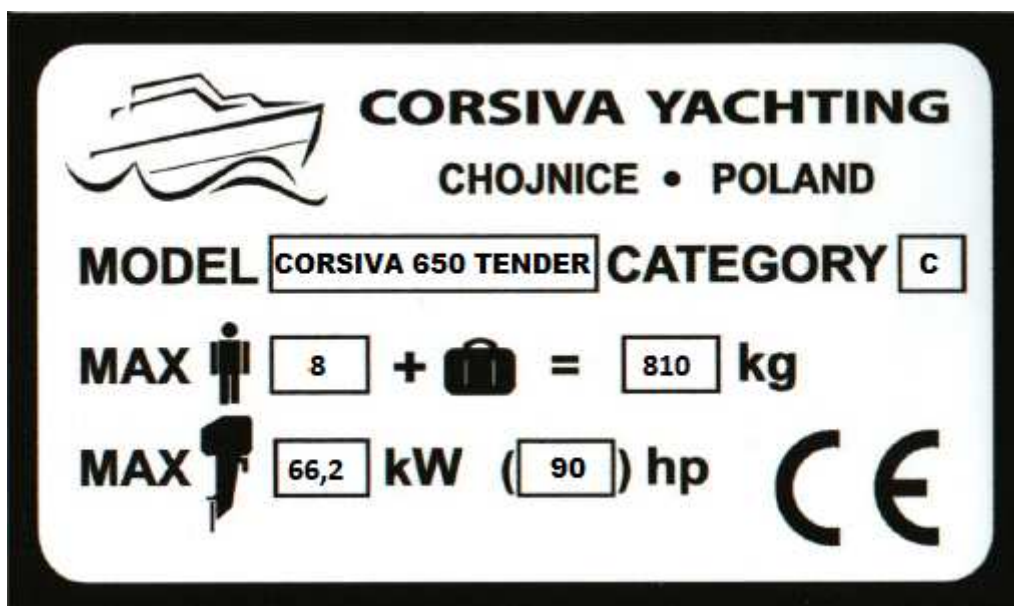

PL	– Country code
COR	– Manufacturer’s identification
65T05	– Serial number
C	– Production month (A – January, B – February, C – March, etc.)
0	– Production year (e.g. 2014 – 4, 2016 – 6)
20	– Model of the year (e.g. 2015 – 15, 2016 – 16)

4.2. Builder's plate

In the cockpit of CORSIVA 650 TENDER the builder's plate is placed.



The builder's plate includes:

C	Yacht design category – „INSHORE”.
max.  x 8 + 	Max. load which cannot be exceeded by the boat's capacity defined by the manufacturer, which includes: 8 people + personal equipment
max. 	Max. power of an outboard engine (kW).
	The CE sign is the confirmation that the boat complies all applicable requirements of Recreational Craft Directive 2013/53/UE Recreational craft and personal watercraft.

4.3. Declaration of Conformity of Recreational Craft

Conformity assessment includes all information which are established for market controlling institutes.

In Declaration of Conformity the manufacturer is issued under the sole responsibility that the boat complies with all applicable requirements of the Directive.

5. STABILITY AND BUOYANCY



COPY

RAPORT Z BADAŃ (MODUŁ A1)
EXAMINATION REPORT (MODULE A1)

Nr
No. CW/RCD/3240/2020

ZAŚWIADCZA SIĘ,

że Polski Rejestr Statków S.A. (PRS) przeprowadził odpowiednią procedurę badania wymienionej niżej jednostki rekreacyjnej i stwierdził, że spełnia ona zasadnicze wymagania określone w załączniku I do dyrektywy 2013/53/UE (RCD), w następującym zakresie:

THIS IS TO CERTIFY

that Polski Rejestr Statków S.A. (PRS) has undertaken the relevant examination procedure for the recreational craft identified below, which was found to meet the essential requirements of the Annex I to Directive 2013/53/UE (RCD), within the following scope:

A.3.2 Staleczność i wolna burta
Stability and freeboard

A.3.3 Wyporność i pływalność
Buoyancy and flotation

Producent Manufacturer	CORSIVA YACHTING Artur Grugel, Ciechocin, ul. Główna 4, 89-620 Chojnice, Poland		
Nazwa typu Brand name	CORSIVA 650 TENDER	Rodzaj jednostki Type of craft	łódź motorowa / motor boat
Kategoria projektowa Design category	C	Materiał kadłuba Material of hull	lps / GRP
Długość kadłuba Length of hull	6,45 m	Szerokość kadłuba Beam of hull	2,50 m
Maksymalna moc silnika(ów) Maximum engine(s) power	66,2 kW	Powierzchnia ożaglowania Sail area	— m ²
Masa jednostki pustej wyposażonej Light craft condition mass	950 kg	Maksymalna liczba osób Maximum number of persons	8
Maksymalna nośność Maximum load	940 kg		

Informacje dodatkowe
Other information Masę jednostki pustej wyposażonej podano bez silnika przyczepnego.
The light craft condition mass is given without an outboard engine.

Badania jednostki przeprowadzono zgodnie z normą
The examinations of the craft were carried out according to the standard

EN ISO 12217-1:2017
(PN-EN ISO 12217-1:2017-12)

Wyniki tych badań są opisane w sprawozdaniu nr
The results of these examinations are described in the report No.

KI/RW/11/20

Raport traci ważność po wprowadzeniu zmian w konstrukcji i wyposażeniu jednostki bez uprzedniego uzgodnienia z PRS.
This report becomes invalid after modifications in construction or equipment of the craft without prior agreement with PRS.

Nr Rejestru PRS
PRS Register No. 637793



(Handwritten signature)
Jacek Papiński

Gdańsk, 2020-03-03



Nr jednostki notyfikowanej
No. of Notified Body
1463

Polski Rejestr Statków S.A.
al. Gen. Józefa Hallera 126
80-416 Gdańsk, Poland

Tel. (+48) 58 75 11 273
Fax (+48) 58 34 17 769
e-mail: dc@prs.pl
www: http://www.prs.pl/

**DANGER**

Information about stability and freeboard, floatation and buoyancy is fulfilled only when:

- ✓ The weight of empty boat (with engine) does not exceed 1140 kg,
- ✓ The maximum power of engine does not exceed 66,2 kW

Remember:

- ✓ any change in arrangement of the masses on the side (eg. the addition of a fishing tower, a change in the engine etc.) can significantly affect the stability, trim and behavior of the boat,
- ✓ amount of bilge water should be as small as possible,
- ✓ stability is decreased by adding any high-mounted weight,
- ✓ gaps in bad weather, lockers, doorways should be closed to minimize the risk of flooding,
- ✓ stability may be reduced when towing,
- ✓ air chambers can't be pierced,
- ✓ breaking waves are a serious threat to stability.

**CAUTION**

The fulfillment of the stability requirement and freeboard as well as buoyancy and flotation does not guarantee the boat will not overturn or sink if all criteria of exploiting the boat are not kept.

The helmsman of boat is responsible for complying to proper sea practice in reference to safety of crew and boat.

6. DESCRIPTION OF BOAT

The boats is made of durable glass-reinforced polyester (GRP), as well as vinylester-glass reinforced laminates. and other high class materials, guarantee trouble-free use of boat for years.

CORSIVA products are applied with such technical solutions which allow getting the optimal stability, reliability and control at the swerves as well as safety at overcoming waves.

6.1. Technical data

The boat is full deck design with an outboard engine.

Length of the hull	6,45 m
Beam of the hull	2,5 m
Draft	0,4 m
Weight of an empty boat + engine	1140 kg
Maximal boat load*	940 kg
Total weight of boat including crew and equipment	2080 kg
Maximal weight of the crew with luggage.	810 kg
Weight for transport on a trailer	1480 kg
Fuel tank	70 L
Water tank	56 L
Maximum engine power	66,2 kW
Crew	8 people

*The maximal boat load amounts of:

- people,
- personal things and safety equipment,
- supplies, (eg. food, drinks),
- portable inboard accessories (eg. movable fuel tanks, cutlery, dishes, kitchen utensils),
- portable navigational/electronic equipment (eg. maps, tablets, compasses),
- tools, spare parts (eg. wrenches, screwdrivers, hammers and so on),
- fuel,
- potable water,
- sewage,
- bilge water,
- life raft.



CAUTION

Never exceed the safety limit defined by the constructor in reference to the maximum load of boat.

Corsiva 650 Tender boat can be maximally loaded with 940 kg of weight.



WARNING

While loading the boat, never exceed the maximal recommended load.

Always carefully load the boat and properly place weights to maintain designed trim (approximately equal to the keel). Avoid placing heavy weights high.

7. ENGINE

The manufacturer leaves the derived hoses in engine compartment so its dealer or customer could attach the engine in the future. (see the photo).

To drive the boat, you should apply the motor with the maximum power recommended by manufacturer of the boat – max. 66,2 kW (90 HP). The engine might be with a long column.



The engine should be in such a position so it wouldn't allow the screw to cavitate. Cavitation of screw reduces the engine efficiency and in consequence the towing power. The excessive diving of engine introduces additional resistance of hull, which reduces the sailing speed.



CAUTION

Always follow the rules of maintenance and service included in the owner's book by the engine manufacturer, in particular:



- ✓ apply the suitable fuel or the mixture with the proper proportion of oil and the fuel,
- ✓ check the level of fuel tank before starting the engine,
- ✓ after starting the engine check if cooling water is carried away through the exhaust,
- ✓ do not make any noise or waves in the harbor, do not exceed the speed limit,
- ✓ follow the manufacturer's instructions while usage, maintenance and winter storage of the yacht,
- ✓ do not use the engine with power exceeding the acceptable power of the boat.



CAUTION

Carry out the inspection of driving screw after its intensive exploitation. It will prevent its damage, let you keep the screw in good state and lengthen the vitality of engine.

Sailing to the shallow shore, especially from a stern side can lead to damage or loss of the lower part of the engine.

7.1. Engine compartment

Hiding the engine in compartment makes boarding or leaving from the deck easy while the boat is stern moored. Additionally, hidden engine reduces the noise, which a running engine produces, improving for crew comfort during cruises.

The engine compartment of the boat is a special place and special attention should be devoted to it, due to the gravitational excretion of exhaust gases.

7.1.1. Gravitational ventilation



Ventilation grates are placed on both sides of a engine compartment as well as its cover. They are for supplying fresh air and shedding outside exceeded heat and petrol fumes.



DANGER

NEVER cover the ventilation grills.

NEVER modify the ventilation system of the engine compartment of the boat.

7.1.2. Mechanical ventilation



The exhaust gases from the engine exhaust are discharged through a hose, which on the one side is connected to the engine, and on the other to the end of exhaust, which exhausts them out of the boat.

The exhaust end is obligatory mounted on the back wall of the stern.



DANGER

The threat of life loss.

NEVER INTERFERE IN EXPULSION OF EXHAUST SYSTEM!

Any interference with exhaust system brings unsealing the system, and therefore the risk of exhaust gas poisoning.

Apart from the gravitational ventilation system there is a mechanical exhaust ventilation system which removes an excess of exhaust gases to the atmosphere.

Suction of an exhaust system is on the left side of the engine compartment.

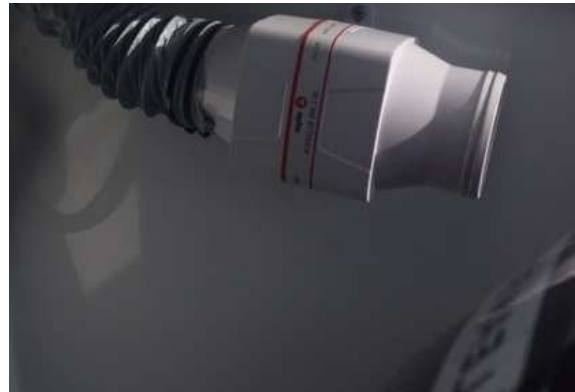

DANGER

The exhaust fan should be turned on before starting the engine and should work at all times when engine is running.



8. STEERING SYSTEM

8.1. Boat steering system

Steering the boat is done by the steering-wheel.

Throttle installed on the right side of control console is used to:

- ✓ change the direction of driving screw rotation,
- ✓ increase or decrease the engine rotations,
- ✓ change the engine tilt angle (trimming),
- ✓ emergency stop of engine.

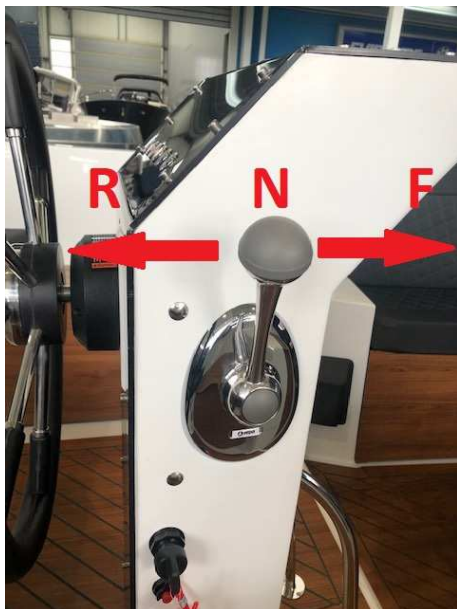

The control handle has a neutral button, which allows you to run and heat the engine before switching gears. At the same time it has a standard safety switch that prevents starting the engine when switching the gearbox.

N – neutral position – safe position of throttle lever to start the engine.

F – forward gear – indicated to move lever from N to F position very slowly.

R – reverse gear – throttle lever shouldn't be suddenly moved from N to R position – it can damage the gear. You should lose the yacht's speed before moving the lever to R position.

Control console instruments:

- ✓ **engine switches**

It's for turning on and off the engine.

- ✓ **emergency engine switch off**

The emergency switch which stops the engine at danger, for example: when the helmsman falls overboard. You can't use it for regular engine stopping.



✓ **steering buttons**

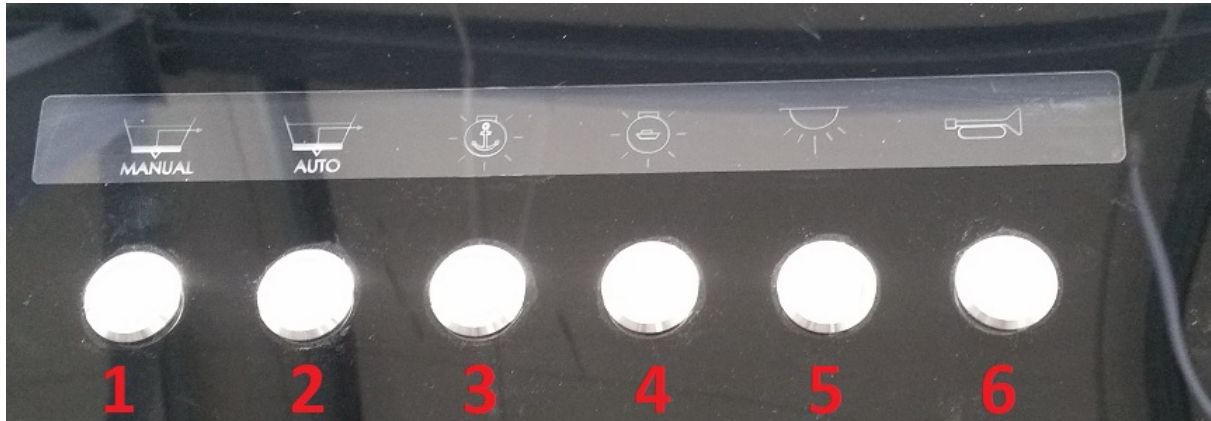

The panel contains starting devices buttons:

1. bilge pump - manual function (the pump turns on only when the button is switched and held on),
2. bilge pump - automatic function (after pressing the pump is still active),
3. the top white lamp 360° - navigation lights,
4. lamps red and green - navigation lights,
5. lamps on the board,
6. horn.

✓ **additional devices**

Additionally, it is possible for the dealers or customer to install additional equipment, like tachometer, gauge and others.

8.2. Navigation lights

Navigation lights are the same as positional lamps, which are: side lights and 360° top light. They have to be switched on (in accordance with the marine law) at night when the boat moves or when it stands on anchor.



DANGER

Never use the anchor light and engine light at the same time.
 Never operate the boat at night or in poor visibility without the proper lighting.
 Turned on proper navigation lights in accordance with COLREG, protect you and the boat.



CAUTION

Check proper working of navigation lights before sailing and make sure that the boat always has a spare bulb of the same power.

8.3. Steering system

On the boats are mounted two types of control system:

ENGINE < 90 HP	ENGINE > 90 HP
The mechanic steering system consists with:	The hydraulic steering system consists with:
<ul style="list-style-type: none"> ✓ steering wheel, ✓ gear steering system, ✓ steering system cord. 	<ul style="list-style-type: none"> ✓ steering wheel on steering panel, ✓ hydraulic pump, ✓ flexible pressure hose and connectors, ✓ hydraulic cylinder



CAUTION

The control system requires periodic inspections, especially paying attention to:

- ✓ hydraulic leaks,
- ✓ proper conduct of hydraulic hoses/steering links,
- ✓ proper level of hydraulic fluid,
- ✓ safe connection to the steering wheel.

In case of any control system failure immediately contact the manufacturer of the boat.

Lack of maintenance or improper maintenance will trigger the loss of control of the boat when sailing and consequently can lead to personal injury or death of crew members.

8.4. Field vision from the helm's position

Helmsman of a boat should be assured with the wide angle of sight from the main steering position.



CAUTION

For safety reasons, a helmsman of a boat should pay particular attention to:

- ✓ weight of load and its location,
- ✓ speed,
- ✓ sudden acceleration,
- ✓ state of water area,
- ✓ weather conditions, such as: rain, drizzle, fog,
- ✓ lighting of a boat at dusk and night,
- ✓ people and moveable elements around the steering area.

9. FUEL SYSTEM

The boat can be equipped with an integral system of fuel. Every fuel tank is made according to PN EN ISO 10088 and is CE certificated.

The fuel system consists of:

1. fuel inlet,
2. fuel tank under the cockpit,
3. air vent,
4. engine.

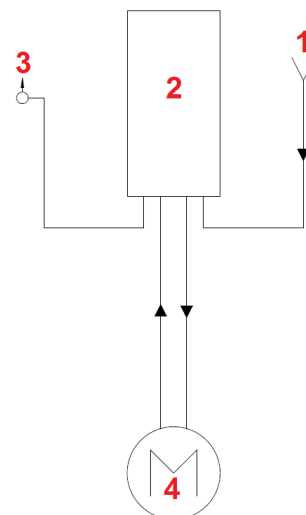

DANGER

Explosion and fire hazard

Never:

- ✓ smoke, or use open fire while fueling or when you work above the system fuel,
- ✓ use the open fire to check the tightness of fuel tank,
- ✓ keep the fuel or flammable substances in tightly closed compartment,
- ✓ cover the ventilating checks of compartments in which the fuel tank is. They should be still open, that fuel vapours could not gather.



WARNING

Check regularly the fuel installation – minimum twice a year.

When you notice, that the state of fuel installation gets worse or it's damaged you should immediately change the affected elements.



WARNING

When you detect the fuel leakage, close the fuel valve (if there is any) and repair the system before starting it again.

The fuel system should be repaired by the qualified person.



CAUTION

Always

Follow the engine manufacturer's instructions contained in its manual. You will avoid the errors and keep full rights to the warranty.

10. ELECTRICAL INSTALLATION

The boat is equipped with electrical installation of 12V DC.

The main boat energy is the battery with the installation adequate voltage.

The battery is located in compartments. Before cruise, check the battery level.

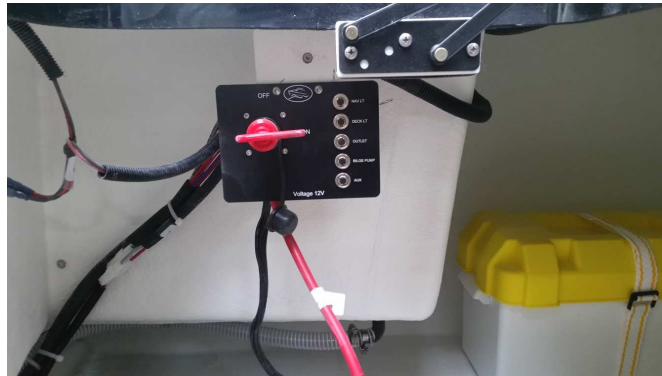

CAUTION

Always:

- ✓ check the battery and charging level before sailing,
- ✓ take battery from a boat before winter season or before long time when the boat will not be exploited.



CAUTION

Never:

- ✓ work on electrical installation, when it's in use,
- ✓ modify the craft's electrical system or relevant schemes; any modifications and maintenance should be performed by a qualified marine electrician,
- ✓ leave the yacht unattended with the working electrical system.



CAUTION

Remember, before starting work, turn off the main power switch!

Main power switch.



The main power switch is located inside the locker under the helmsman seat.

Scheme of electrical installation*

*) Scheme of electrical installation depends on the equipment ordered by the customer.

Electrical installation diagram (simplified) Corsiva 650 Tender

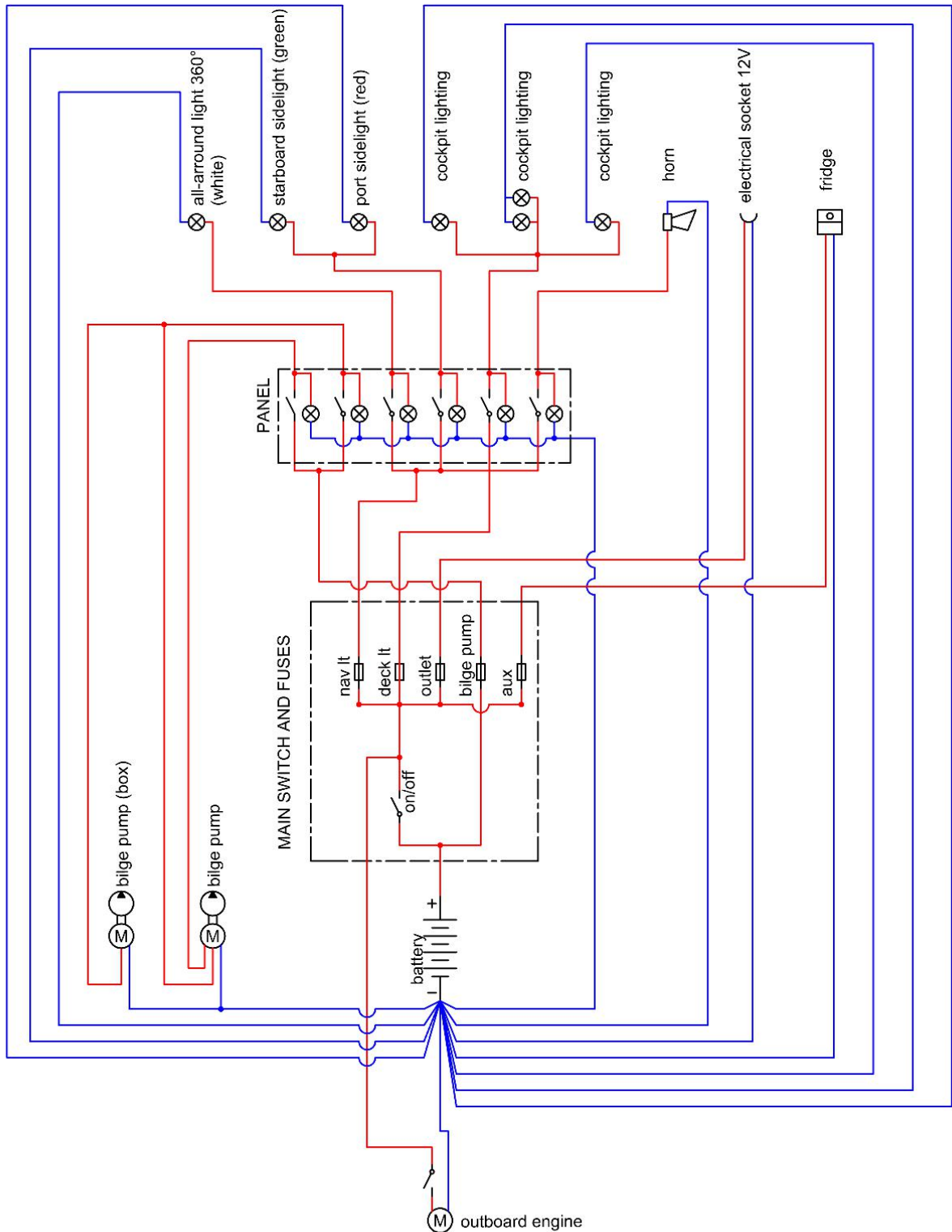

11. SANITARY SYSTEM

On the boat, there is a chemical toilet in bow compartment provided.



The rules of its use and maintenance are described in the manual book of toilet manufacturer.



CAUTION

Before using the toilet make sure it is not clogged up.



CAUTION

Before each winter season the boat should be disposed of whole sewage from the installation.



CAUTION

While using toilet **you should not:**

- ✓ throw rags, dressings and hard objects into it,
- ✓ overflow the waste tank.

Tank waste should be emptied at the agreed and appointed places (harbors).

12. BILGE INSTALATION

The bilge system is installed in the galley under the floor.

Automatic bilge pumps



Hand bilge pump



Bilge instalation consists of:

1. two automatic bilge pumps,
2. one manual bilge pump,
3. outlets and side passages,
4. hoses connecting pumps with outlets and side passages.

Automatic bilge pumps can work automatically after powering-up the float switch or by hand, operating from the switch panel if it is necessary.

Hand bilge pump is under the deck.



DANGER

Installed bilge installation is not intended to dry the damaged yacht.



WARNING

Before each season check the state of connections and the tightness of bilge installation.

Regularly check the bilge pump work.

Regularly remove dirt from inlet of sucking bilge pump basket.

Never use flammable solvents for bilge cleaning.



CAUTION

Do not discharge oily water overboard, in moment when boat is afloat.











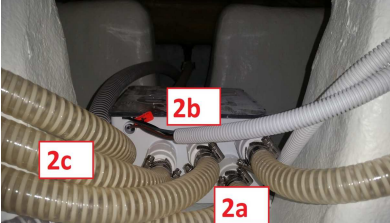

CAUTION

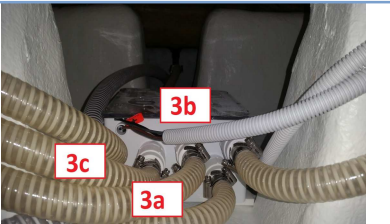
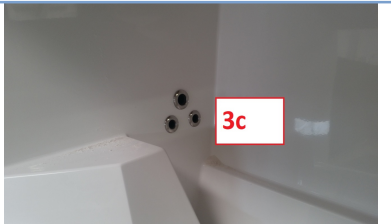
It is recommended to have the onboard bucket which you can use in sudden cases.

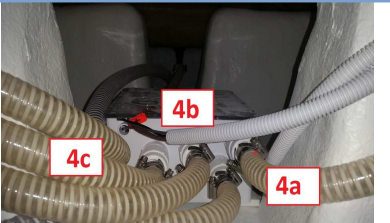
13. BOTTOM, SIDE AND DECK OPENINGS

The openings in deck, bottom and side may pose danger as water can get into the boat.
Sea valves are served manually, therefore they should be controlled.

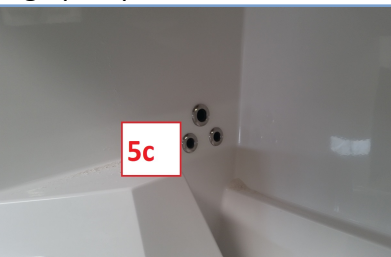
1	The drain from anchor locker.		
	 <p>1a</p>	 <p>1b</p>	
2	The deck drain to the engine compartment outlet with automatic bilge pump.		
	 <p>2a</p>	 <p>2b 2c</p>	 <p>2c</p>
3	The left locker drain to the engine compartment outlet with automatic bilge pump.		
	 <p>3a</p>	 <p>3b 3c</p>	 <p>3c</p>
4	The right locker drain to the engine compartment outlet with automatic bilge pump.		
	 <p>4a</p>	 <p>4b 4c</p>	 <p>4c</p>
5	The bilge drain to the engine compartment outlet with automatic bilge pump.		
	 <p>5a</p>	 <p>5b</p>	 <p>5c</p>

6 The bilge drain to the engine compartment outlet with manual bilge pump.

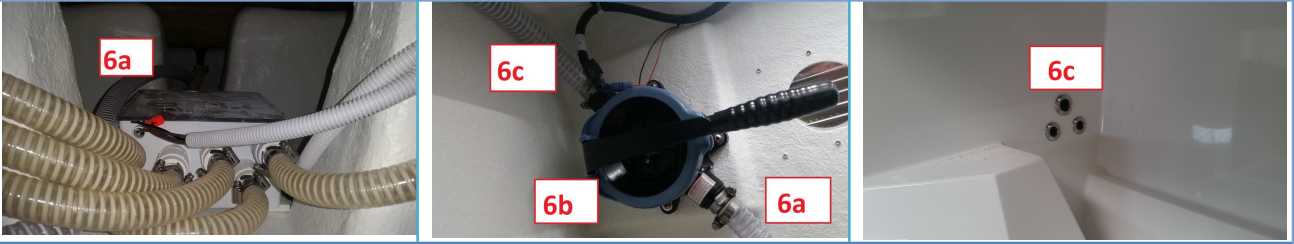

DANGER

Never:

- ✓ leave the unattended yacht with open valves,
- ✓ change the construction of valves connection.

14. FIRE PROTECTION

The main source of fire on the boat is open fire such as a lighter, candle or matches.



WARNING

Before using you should:

- ✓ get to know with manufacturer's instruction in details,
- ✓ equip the boat with fire extinguisher and extinguishing blanket,
- ✓ pay attention to the usage of evacuation exits.



CAUTION

The owner/helmsman should:

- ✓ check the extinguishing equipment periodically according to requirements written on the equipment,
- ✓ replace the fire extinguishers after their expiration date or when they were used.

15. UPHOLSTERY

The upholstery should be installed according to the scheme as pictured.

Each cushion has its own marking, which can be found on the label - this will make the eventual replacement of individual damaged cushions easier

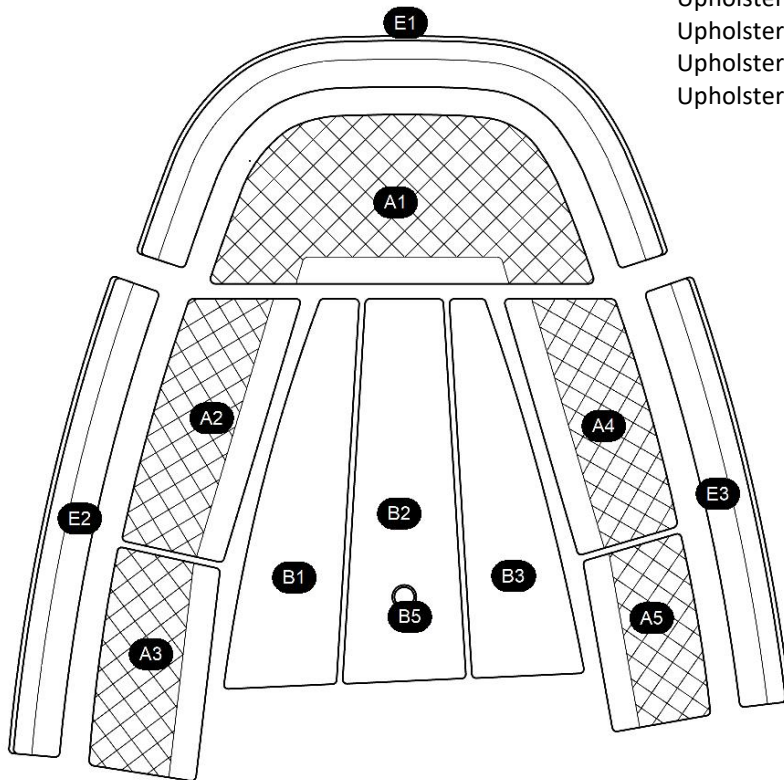

Upholstery markings:

Upholstery marked with the letter E - backrest

Upholstery marked with the letter A - seat

Upholstery marked with the letter B - sun deck

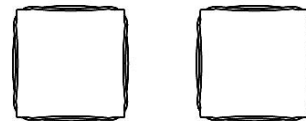
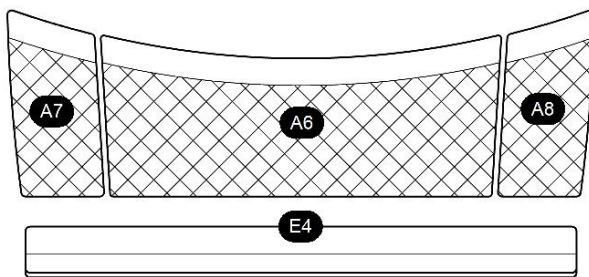

2 x pillow

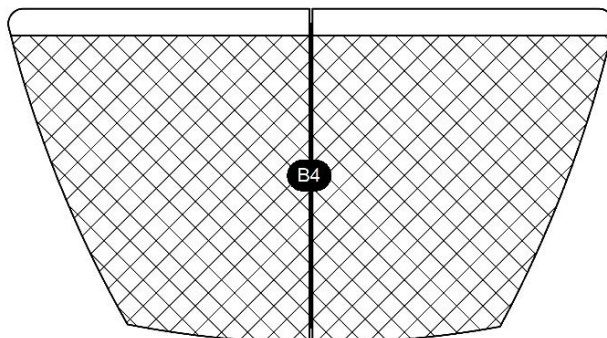

Maintenance

Upholstered elements will be protected well enough through regular cleaning with a solution of tepid water and gentle detergents or car vinyl cleaners.

After they have been cleaned, they should be flushed and dried so as to avoid molding. Upholstered elements should be dried and covered with anti-molding spray.

During mooring, cover the boat with a mooring cover to protect the upholstery from weather conditions. In case if there is no mooring cover, place the upholstery in the lockers.



CAUTION

Some car, domestic or industrial cleaning detergents can cause damages or change of colour of upholstered elements. Solvents and cleaners for dry cleaning, containing dyes, wax or paraffin wax, should be used carefully. Any stains should be removed immediately. If they are left for some time, they may become hard to remove.

15.1. Sundeck

According with customer's wish the boat can be retrofitted with the mattresses, which can create a sunbathing place for crew.

You should turn special attention to safety and proper care of mattresses principles.

Stern sundeck



Bow sundeck



DANGER

The maximum speed where people are on the sundeck is 15 km / h and max. 0.5 m height wave.

**DANGER**

Stern sundeck is adapted toThe stern sun deck is designed for only 2 people.

It is forbidden for small children and non-swimmers to stay on the stern sun deck without life jackets and proper supervision.

Never

- ✓ enter the stern sundeck, when boat is moving,
- ✓ stand up on a stern and bow sundeck, when boat is moving.

Always

- ✓ lie or sit on sundecks, when boat is moving,
- ✓ hold rails on during boat's maneuvering.

16. MAINTENANCE, PAINTING, CLEANING

Your boat – the deck, hull and some interior parts were made of fiberglass.

To keep the boat in good condition, wash the fiberglass regularly. Wash the boat with clean water with soft detergents, e.g. water with soap.

Do not use abrasive cleaning, solvents, ammonia, chlorine or acetone as these will damage the gel-coat surface of the boat.

In extreme cases, special cleaners may be used to remove sea growth or algae from the hull. Growths and algae can worsen the efficiency of the boat.

Do not use wire brushes, abrasive paper or paste to remove growths and algae. The arisen scratches may store dirt, growth and algae.

The hull bottom should be painted with anti-fouling paint.

Before painting the boat, please consult the manufacturer which paint is the best for your boat type.

**WARNING**

Cleaning or washing with solvents can cause fire, explosion and health problems. Always wear necessary protective clothing while cleaning (gloves, goggles, protective mask).

**CAUTION**

Get acquainted with safety code of environment protection before painting the boat. Get acquainted with suggestions and instructions of using the products before you start using them. Follow the instructions of the paints' and varnishes' manufacturer. Consult the local authorities to learn the current regulations concerning environmental protection.

**CAUTION**

To maintain the warranty on the hull's boat should be serviced every year and the hull should be protect by anti-fouling paint.

16.1. Stainless steel

Constructions of bow and stern railings, as well as other metal elements were made of corrosion resistant steel, which means polished stainless steel.

**WARNING**

If you want to keep stainless steel fittings in good condition, **you should:**

- ✓ clean all fittings only with soap and water,
- ✓ use a good quality car wax to protect the stainless steel,
- ✓ wash the deck fitting with sweet water and clean from salt deposits after each sailing on salt water,
- ✓ check the fittings regularly, especially frequently if you sail on salt water and high level of humidity and temperature,

you should not:

- ✓ use abrasive materials or acids,
- ✓ store the boat after the season in a closed and unventilated room for a long period of time.

**CAUTION**

The guarantee does not include the slight rust spots caused by lack of or inappropriate maintenance of stainless steel fittings.

17. TRAILERING AND LAUNCHING

During the boat transportation it is very important to keep the boat in the horizontal position.

Boat transport should be carried out only by a qualified person.

To control hull movements during lifting the operating lines should be fastened to bow and stern cleats, which makes possible to direct the boat, when it is in the air.



WARNING

People presence under lifted boat or in its neighborhood is strongly prohibited.

When placing the boat on a trailer, make sure that the hull symmetry axis is exactly like the trailer and that the support rollers are properly positioned. Their location is important, because a whole boat weight is put on them.



WARNING

Remember that incorrect distribution of crutches can damage the hull!

Bow should be tightly placed in fitted place and supported by fastening it to the tow ear placed on bow.

Boat should be fastened with spansets to the trailer.



WARNING

Remember to use the transport belts with proper force. Too excessive belt tension can damage your boat!

Traverse lifting

Traverse regulates the lifting straps, due to keeping a certain spacing and not clutching a hull's boat while lifting.

Other solutions can damage the hull of the boat.

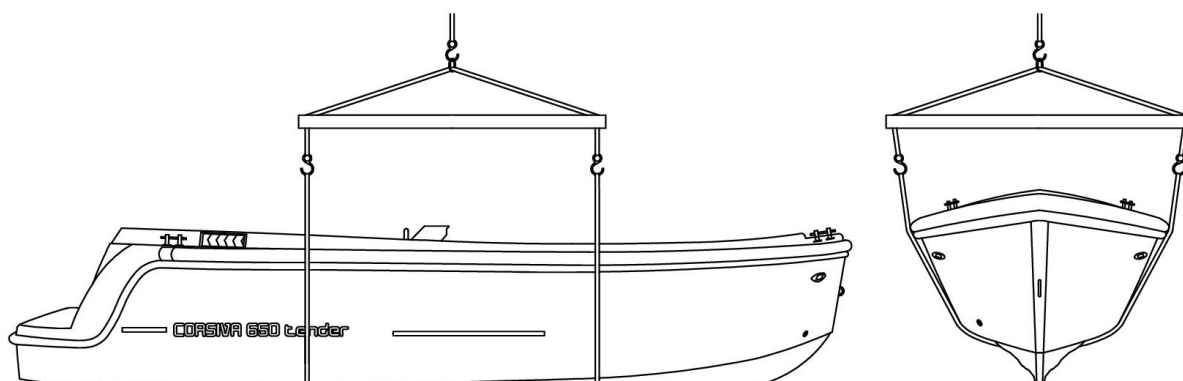

18. ANCHORING, MOORING AND TOWING

The boat's owner / helmsman is responsible for equipping the boat with an anchor, anchor chain / anchor rope, mooring and towing lines ready to use.

Anchorage equipment

Place the anchor in the anchor compartment. Anchor rope is secured to the cleat.

Recommended equipment

anchor: 7-8 kg

	Material	Diameter	Length
Anchor rope	polyamide	10 mm	25-30 m



CAUTION

Before going on a cruise every helmsman should check if there is an appropriate anchor with a rope or chain. You have to notice that an anchor with rope must be always ready to use.

Mooring equipment

Be careful so the mooring ropes would not tangle in propeller or around rudder.

Recommended equipment:

	Material	Diameter	Length
Mooring rope	polyamide	10 mm	2 × 15 m

Towing equipment

Before towing, fasten the towing rope to both mooring cleats on a bow. Other places on the boat are improper to fastening the towing rope.

The anchor rope can replace the towing rope, but it is recommended to have a special rope, with the same diameter, designed for towing.

Recommended equipment:

	Material	Diameter	Length
Towing rope	polyamide	10 mm	25-30 m



CAUTION

Adjust the towing speed so the towing doesn't damage the boat.

19. ENVIRONMENTAL PROTECTION

The chapter contains the indispensable information how the crew should protect the natural environment during sailing.

Remember that protecting natural environment is strictly regulated not only in many parts of Europe but also all over the world.

The owner is responsible for knowing all valid requirements on the particular water area and for obeying them.

19.1. Oil derivatives

The leakages of fuel or oil pollute the environment and pose a danger to wildlife.

**WARNING**

Never spill fuel or oil into water.
It is prohibited and you can get fined.

**CAUTION**

Treat any oils / oil derivatives as chemical waste.

Always

In case of oil leakage, try to recognize its source as fast as possible.
Remove oil derivatives wastes (used oils) in a proper way.

Never:

Overflow the fuel tank during filling it. All works concerning the engine reparation should be performed on land.

Throw dirty bilge water overboard.

Store any rags to wipe oil derivatives or chemical substances.

After using a rag, dispose it on land according to valid regulations.

19.2. Sewage and waste removal

Removing sewage into navigation waters is strictly prohibited among many water areas. The user of the boat is required to know all the valid local rights concerning the disposal of liquid sewage into navigation waters.



WARNING

If the bilge water is dirty avoid switching on the automatic bilge pump in order not to remove the waste illegally.

Do not remove the contaminated bilge water overboard.

Sewage removal should take place in appointed places on land.

Produced waste should be kept in small durable bags and thrown out in appointed places on land.



WARNING

In case if you lack the place for storing waste on the boat, you can only remove organic waste to water.

20. REMOVING MALFUNCTIONS

Do not make repairs alone, unless you are authorized to do it; get only professional advice and information. Use only certified materials and replaceable parts.



WARNING

Do not interfere the boat's construction nor install any additional equipment or change anything.

Changes may be carried out only after consulting the boat's manufacturer and obtaining its written consent.

If an owner makes changes in boat's construction or equipment without the manufacturer's consent, it will cause the warranty loss.

An owner takes responsibility for all consequences arose by changes made by himself.