

OWNER'S MANUAL  
MOTOR BOAT

# CORSIVA 595 TENDER



Manufacturer

Corsiva Yachting

<http://corsiva.pl/>

**INDEX**

<b>1. INTRODUCTION .....</b>	<b>2</b>
<b>2. STAGE OF DANGER.....</b>	<b>3</b>
<b>3. GENERAL SAFTY RULES.....</b>	<b>4</b>
3.1. Safety.....	4
3.2. Passengers on board .....	4
3.3. Life-saving equipment.....	5
<b>4. IDENTIFICATION OF BOAT.....</b>	<b>6</b>
4.1. Craft identification number (CIN).....	6
4.2. Builder's plate.....	7
4.3. Declaration of Conformity of Recreational Cratf.....	7
<b>5. STABILITY AND BUOYANCY .....</b>	<b>8</b>
5.1. Weight of boat and maximum capacity .....	10
<b>6. DESCRIPTION OF BOAT.....</b>	<b>11</b>
6.1. Technical data .....	11
<b>7. ENGINE .....</b>	<b>12</b>
7.1. Engine compartment.....	13
7.1.1. Mechanical ventilation.....	14
<b>8. STEERING SYSTEM.....</b>	<b>15</b>
8.1. System of steering the boat .....	15
8.2. System of steering.....	17
8.3. Field of vision from helm position.....	17
<b>9. FUEL SYSTEM.....</b>	<b>18</b>
<b>10. ELECTRIC INSTALLATION.....</b>	<b>19</b>
<b>11. SANITARY SYSTEM.....</b>	<b>22</b>
<b>12. BILGE INSTALATION.....</b>	<b>23</b>
<b>13. BOTTOM, SIDE SEA OPENINGS.....</b>	<b>24</b>
<b>14. FIRE PROTECTION .....</b>	<b>25</b>
<b>15. SUNDECK.....</b>	<b>26</b>
15.1. Upholstery .....	27
<b>16. MAINTENANCE, PAINTING, CLEANING.....</b>	<b>28</b>
16.1. Stainless steel .....	29
<b>17. TRAILERING .....</b>	<b>30</b>
<b>18. ANCHORING, MOORING AND TOWING .....</b>	<b>31</b>
<b>19. ENVIRONMENTAL PROTECTION .....</b>	<b>32</b>
19.1. Oil derivatives.....	32
19.2. Sewage and waste removal.....	32
<b>20. REMOVING FAILURES .....</b>	<b>33</b>
<b>21. WARRANTY.....</b>	<b>34</b>

## 1. INTRODUCTION

The Owner's manual, which you received together with a boat, will help you to operate your motor boat CORSIVA 595 TENDER safely and appropriately so you may use it with a pleasure. Manual contains the description of the boat, its equipment and installation systems as well as practical information about their use and maintenance.

**Read the information carefully before using the boat.**

This Owner's Manual is not a detailed guide boat maintenance or troubleshooting. In case of difficulties, contact to your manufacturer or his dealer.

Always employ trained and competent people for maintenance or repairs.

Repairs which may impact on safety characteristics of the yacht should be evaluated, carried out and as documented by competent people.

**Boat manufacturer not responsible for the modifications made after with his consent, therefore, any modification of boat shall be repeal entitled to guarantees.**

Always keep your boat in good condition and Take into account the deterioration of that will followed over time and as a result intensive use or improper handling of the boat.

Each boat, regardless of how it is strong, can be severely damaged if is not properly used.

Always adjusting the speed and direction of the boat to the conditions on the waters.

This manual is for the owner is not a course for safe yachting or sailing skills.

If this is your first boat or if you change the type, you do not know, for your own comfort and safety, make sure that you got experience in leading the boat and its operation. Your dealer, national sailing federation or boats club is pleased to provide you with information on local marine schools or competent instructors.

**PLEASE KEEP THIS OWNER'S MANUAL  
IN THE SAFE PLACE  
AND HAND IT OVER TO A NEW OWNER WHEN  
YOU SELL THE BOAT**

*With wishes of successful cruises  
Corsiva Yachting*

*\*) We are an intensively developing company and our boats are constantly improved, therefore, some of the solutions and information included in this Manual might not apply to your boat.*

## 2. STAGE OF DANGER

The manual contains three kinds of sign, which are supposed to turn your attention to the actions and situations which may cause danger for health or life if not realized.

Following:



### DANGER

The sign warns before appearing the highest danger, which can cause the durable damage of body or death unless the appropriate safety actions are taken.



### WARNING

The sign warns before appearing the danger, which can cause the durable damage of body or death unless the appropriate safety actions are taken.



### CAUTION

The sign reminds about applying the safety behavior or turns attention to inappropriate behavior, which may result in the injuries of body, the damage to the boat as well as its elements or damages to the natural environment.



*A warning sign used in accordance with PN-EN ISO 11192 Graphical symbols*

### 3. GENERAL SAFTY RULES

#### 3.1. Safety

Even if it all planned the safety of the sailing remains heavily dependent on the weather, sea conditions and the experience and knowledge of the crew.

Always check to-date weather forecast before leaving and see that the circumstances should be expected to the category of construction of the boat.

Before you prepare your boat for sailing, check local legislations under which the waters what restrictions apply.

Check the restrictions for swimming; speed limit, restrict the use of outboard noise reduction, etc..

#### Stimulants

Never swim under the influence of alcohol or drugs.

The combination of noise, vibration, sun, wind and water movement causes fatigue. The effects of alcohol on the water are worse than on land.



#### WARNING

Stimulants and shipping not go hand in hand. Operate a boat while under the influence of drunkenness or other means is illegal and dangerous. Weakening eyesight or assessment of the situation could lead to disaster

#### 3.2. Passengers on board

During the boarding of passengers, stop the engine.

By moving the lever of engine to the neutral position is not sufficient.



#### WARNING

Do not allow anyone to sit on the parts of the boat in places not intended for. In particular, seatbacks, colon, transom, bow, or anywhere that an unexpected acceleration or sudden stop will cause a person falls overboard or into the interior of the boat.

The helmsman of the is responsible for passengers and cargo.

Do not overload the boat.

The boat are evaluated relative to the maximum load and capacity.

If in doubt, contact your dealer or the yacht manufacturer.



#### WARNING

Always turn off the engine when the boat is located near people in the water. Even at low engine power screw can cause serious injury.

### 3.3. Life-saving equipment

On the yacht should be appropriate safety equipment (life jackets, safety harnesses, etc.) as appropriate to the type of boat, weather conditions, etc. In some countries it is Required equipment.

Carefully read the manual of a life raft.

The crew should be familiar with the use of all equipment safety and emergency maneuvering (man overboard, towing, etc.). sailing schools and clubs regularly organize training sessions.

**WARNING**

Read instructions carefully contained on the life jackets label and follow it.  
Checking the condition of life jackets, make sure it fits in the body.  
Try vest before you fall into the water.

All persons should wear appropriate rescue measures (lifejackets / buoyancy aids), while they are on board. Please note that in some countries there is a legal requirement to wear a permanent rescue means that meets the requirements of their national legislation.

**WARNING**

It is important that children and unwary people who cannot swim were wearing life jackets. Children who cannot swim and require special instruction on how to use life jackets

## 4. IDENTIFICATION OF BOAT

The boat CORSIVA 595 TENDER was manufactured by CORSIVA according to applicable requirements of Annex I to Directive 2013/53/UE of European Parliament and of the Council, Recreational craft and personal watercraft.

The boat CORSIVA 595 TENDER was put to the test by Polish Register of Shipping according with applicable requirements of Annex I to Recreational Craft Directive 2013/53/UE for design category C.

**The design category C - INSHORE** defines the craft has been designed for sailing in coastal waters, bays, lakes and the rivers, where conditions up to and including be a typical wind force Beaufort Force 6° and significant wave heights up to and including to 2 meters.

Such conditions may be encountered on open inland waters, estuaries and coastal waters in moderate weather conditions.

### 4.1. Craft identification number (CIN)

The boat CORSIVA 595 TENDER has two places with the same identification number. First one is placed on the right side of a transom, second one is hidden inside the construction of boat in a place only known to his manufacturer. CIN is needed to identify a boat in case it was stolen.



P	L	-	C	O	R	5	9	T	8	2	I	5	1	6
---	---	---	---	---	---	---	---	---	---	---	---	---	---	---

The craft identifications number includes:

PL	– Country code
COR	– Manufacturer's identification
59T82	– Serial number
I	– Production month (A–January, B–February, C–March, etc.)
5	– Production year (e.g. 2015 – 5, 2016 – 6)
16	– Model of year (e.g. 2015 – 15, 2016 – 16)

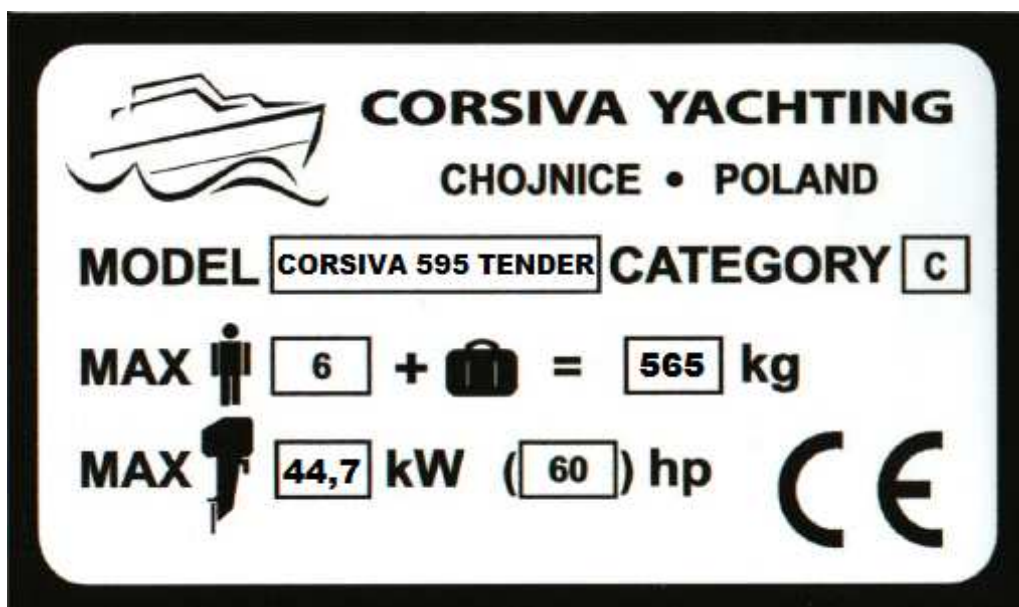

## 4.2. Builder's plate

In the cockpit of CORSIVA 595 TENDER there is placed the builder's plate.



The builder's plate includes:

**C** Yacht design category – „INSHORE”.

max.  x 6 +  Max. number of people and personal equipment which cannot cross the boat capacity definite by the manufacturer, which includes: 6 people + personal equipment

max.  Max. power of outboard engine (kW).

 The CE sign is the confirmation that the boat complies applicable requirements of Recreational Craft Directive 2013/53/UE Recreational craft and personal watercraft.

## 4.3. Declaration of Conformity of Recreational Craft

Conformity assessment includes all information which are established for market controlling institutes.

In Declaration of Conformity the manufacturer is issued under the sole responsibility that the boat complies with all applicable requirements of the Directive.



## 5. STABILITY AND BUOYANCY



# Polski Rejestr Statków

## RAPORT Z BADAŃ (MODUŁ A1) EXAMINATION REPORT (MODULE A1)

Nr  
No. CW/RCD/1908/2016

### ZAŚWIADCZA SIĘ,

że Polski Rejestr Statków S.A. (PRS) przeprowadził odpowiednią procedurę badania wymienionej niżej jednostki rekreacyjnej i stwierdził, że spełnia ona zasadnicze wymagania określone w załączniku I do dyrektywy 2013/53/EU (RCD), w następującym zakresie:

### THIS IS TO CERTIFY

that Polski Rejestr Statków S.A. (PRS) has undertaken the relevant examination procedure for the recreational craft identified below, which was found to meet the essential requirements of the Annex I to Directive 2013/53/EU (RCD), within the following scope:

A.3.2 Stateczność i wolna burta  
Stability and freeboard

A.3.3 Wyporność i pływalność  
Buoyancy and flotation

Producent Manufacturer	CORSIVA YACHTING Artur Grugel ul. B. Chrobrego 21, 89-600 Chojnice, Polska		
Nazwa typu Brand name	CORSIVA 590 / 595 TENDER CORSIVA 610 TENDER	Rodzaj jednostki Type of craft	łódź motorowa / motor boat
Kategoria projektowa Design category	C	Materiał kadłuba Material of hull	lps / GRP
Długość kadłuba Length of hull	5,75 m	Szerokość kadłuba Beam of hull	2,20 m
Maksymalna moc silnika(ów) Maximum engine(s) power	44,7 kW	Powierzchnia ozaglowania Sail area	— m <sup>2</sup>
Masa jednostki pustej wyposażonej Light craft condition mass	550 kg	Maksymalna liczba osób Maximum number of persons	6
Maksymalna nośność Maximum load	595 kg		
Informacje dodatkowe Other information	Masę jednostki pustej wyposażonej podano bez silnika przyczepnego. The light craft condition mass is given without an outboard engine.		

Badania jednostki przeprowadzono zgodnie z normą  
The examinations of the craft were carried out according to the standard

PN-EN ISO 12217-3: 2013-08

Wyniki tych badań są opisane w sprawozdaniu nr  
The results of these examinations are described in the report No.

KI/RW/45/15

Raport traci ważność po wprowadzeniu zmian w konstrukcji i wyposażeniu jednostki bez uprzedniego uzgodnienia z PRS.  
This report becomes invalid after modifications in construction or equipment of the craft without prior agreement with PRS.

Nr Rejestru PRS  
PRS Register No. 637109



W12 *J. Papiński*

Gdańsk, 2016-06-20

Jacek Papiński



Nr jednostki notyfikowanej  
No. of Notified Body

1463

Polski Rejestr Statków S.A.  
al. Gen. Józefa Hallera 126  
80-416 Gdańsk, Poland

Tel. (+48) 58 75 11 273  
Fax (+48) 58 34 17 769  
e-mail: dc@prs.pl  
www: http://www.prs.pl/

**DANGER**

Information about stability and freeboard, floatation and buoyancy is fulfilled only when:

- ✓ The weight of empty boat with equipment does not exceed 765 kg,
- ✓ The maximum power of engine does not exceed 44,7 kW

**Remember:**

- ✓ any change in arrangement of the masses on the side (eg. The addition of a fishing tower, a change in the engine etc.) can significantly affect the stability, trim and behavior of the boat,
- ✓ amount of bilge water should be as small as possible,
- ✓ stability is decreased by adding any high-mounted weight
- ✓ gaps in bad weather, lockers, doorways should be closed to minimize the risk of flooding,
- ✓ stability may be reduced when towing.
- ✓ air chambers can't be pierced,
- ✓ breaking waves are a serious threat to stability.

**CAUTION**

The fulfillment of the requirement of stability and freeboard as well as buoyancy and flotation does not guarantee the boat will not overturn or sink if all criteria of exploiting the boat are not kept.

The helmsman of boat is responsible for complying to proper sea practice in reference to safety of crew and boat.

### 5.1. Weight of boat and maximum capacity

Weight of an empty boat + engine (for transport on a trailer)	765 kg
Total weight of boat including crew and equipment	1305 kg
Weight yacht in operating condition (outboard + fuel + instrumentation)	795 kg
Maximum exploitation load (6 persons + personal + equipment + inventories)	510 kg



#### CAUTION

Never cross the safety limit definite by constructor in reference to the maximum load of boat.

CORSIVA 595 TENDER can accommodate maximum 6 people + fuel, equipment, gear, outboard engine

⇒ **maximum 755 kg.**

The maximum recommended load takes into account the weight of all persons on the boat, all stocks and personal items, all the equipment is not included in the weight of the empty boat, cargo (if any) and all of consumable liquids (water, fuel, etc.).

The total mass of liquid when all permanently installed tanks are full, is :

- fuel tank 30 L,



#### WARNING

**By loading the boat, never exceed the maximum recommended load.**

Always carefully loads the boat and properly placed weights to maintain design trim (approximately equal to the keel).

Avoid placing heavy weights high.

## 6. DESCRIPTION OF BOAT

The yacht is made of durable glass-reinforced laminate as a monolithic construction and of high class materials, guaranteeing trouble-free use of boat for years.

CORSIVA products are applied with such technical solutions which allow to get the optimal stability, reliability and control at the swerves as well as safety at overcoming waves.

### 6.1. Technical data

The boat is full deck design outboard.

Length of the hull	5,75 m
Beam of the hull	2,20 m
Draft	0,4 m
Displacement with maximum loaded	1305 kg
Displacement light craft condition	550 kg
Maximum load	755 kg
Fuel tank	30 L
Maximum engine power	44,7 kW / 60HP
Crew	6 people

## 7. ENGINE

If a customer wishes, the boat is sold with outboard engine placed in the well in cockpit. In other cases, the manufacturer leaves routed wiring in the engine sump to the customer in the future he could connect the motor (photo).

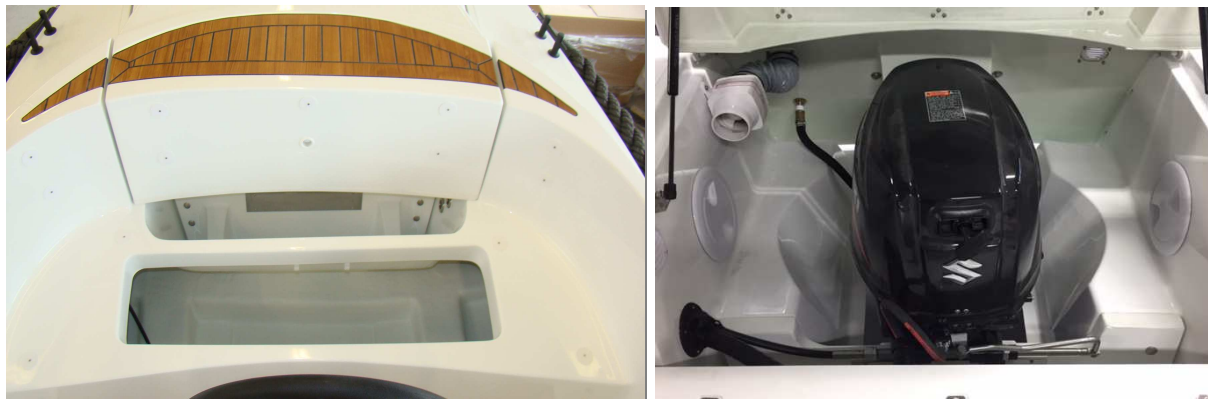

To drive the boat, you should apply the motor with the maximum power recommended by manufacturer of the boat – max. 44,7 kW. The engine might be with a long column.

Cavitation of screw reduces the engine efficiency and in consequence the towing power. The excessive diving of engine introduces the additional resistance of hull, which reduction the sailing speed.



### CAUTION

Always follow the rules of maintenance and service included in the owner's book by the engine manufacturer, in particular:



- ✓ apply the suitable fuel or the mixture with the proper proportion of oil and the fuel,
- ✓ check the level of fuel tank before starting the engine,
- ✓ after starting the engine check if the cooling water is carried away through the exhaust,
- ✓ after turning the engine off, close the vent valve of fuel tank,
- ✓ do not make any noise or waves in the harbor, do not exceed the speed limit,
- ✓ follow the manufacturer's instructions while usage, maintenance and winter storage of the yacht,
- ✓ do not use the engine with power exceeding the acceptable power of the boat.



### CAUTION

Carry out the inspection of driving screw after its intensive exploitation. It will prevent the damage, let to keep the screw in good state and lengthen the vitality of engine.

**Swim to the shallow shore, especially stern can lead to damage or loss of the lower part of the engine.**

### 7.1. Engine compartment

Hiding the engine in compartment makes it easy boarding or leaving from the deck while the boat is moored stern. Additionally, hidden engine reduces the noise, which produces a running engine, improving for crew comfort during cruises.

The engine compartment of the boat is a special place and should be the place to devote special attention, due to the gravitational excretion of exhaust gases.



Inside the engine compartment, both sides are placed vents. Ventilation grilles through a special hose dissipate the excess heat from the engine compartment, vapours engine exhaust and through the openings on the side on the outside.



**DANGER**

NEVER cover the ventilation grills.

NEVER modify the ventilation system of the engine compartment of the boat.

### 7.1.1. Mechanical ventilation

The exhaust gases from the engine exhaust are discharged through a hose, which on one hand is connected to the engine, and on the other to the end of exhaust, which are exhausted out of the boat.



The end exhaust is mounted on the back wall of the stern.



**DANGER**

The threat of loss of life.

**NEVER INTERFERE IN EXPULSION OF EXHAUST SYSTEM!**

Any interference with exhaust system brings unsealing the system, and therefore the risk poisoning from exhaust gas.

## 8. STEERING SYSTEM

### 8.1. System of steering the boat

System of steering the boat's rudder by the steering-wheel.

Steering with an engine is regulated with the engine throttle, which is placed on the right side in cockpit.

**The throttle changes the speed and the direction of driving screw.**

The control handle has a neutral button, which allows you to run and heat the engine before switching gears.

At the same time they have a standard

safety switch that prevents starting the engine when switching the gearbox.



**The throttle changes the speed and the direction of driving screw.**

The single throttle installed on the helmsman's right hand is used to:

- ✓ change the direction of driving screw rotation,
- ✓ increase or decrease the engine rotations,
- ✓ emergency stop of engine.

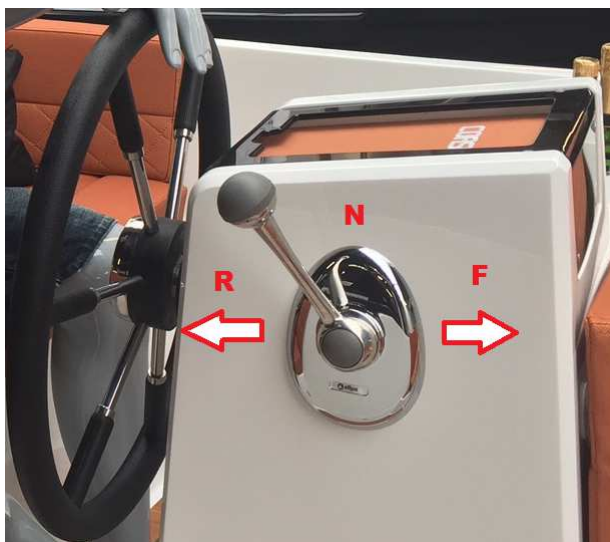

**N – neutral position** – the position of throttle lever to starting of engine.

**F – Forward gear** – be indicated to move lever from position N to F very slowly.

**R – Reverse gear** – shouldn't suddenly remove lever from position N to R – it can damage the gear.

You should lose speed of yacht before move the lever to position R.



Navigational aids. Current receiver.

Engine switch on and off

Engine switch of

The emergency switch which stop the engine in moment of danger, for example: in moment of overboard the helmsman. You can't it use in normal stop of the engine.

Main switch of batteries

It includes electric circuits or it switches off it in emergency situations. His place is on the wall of battery compartments.

Navigation lights.

Navigation lighting is the same as positional lamps, which is: side lights, stern light, top light and anchor light. They have to be switched on (in accordance with the right of road) at night when the boat moves or when it stands on anchor.

Navigation lights control is done with the dashboard / control panel.



#### DANGER

Never use the anchor light and engine light at the same time.  
Never operate the boat at night or in poor visibility without the proper lighting.  
Turned on proper navigation lights in accordance with COLREG protect you and the boat.



#### CAUTION

Check proper working of navigation lights before sailing and make sure that the boat has always a spare bulb of the same power.

Bilge pump switch

Operates the work of bilge pump - through temporary switching on.

## 8.2. System of steering

CORSIVA 595 TENDER boat is equipped with a mechanical control boat.

It consists of:

- ✓ steering wheel,
- ✓ gear,
- ✓ steering system,
- ✓ steering links.



### CAUTION

The control system requires periodic inspection, especially pay attention to:

- ✓ proper conduct of steering links,
- ✓ safe connection to the steering wheel.

In the event of any failure of the control system immediately contact the manufacturer of the boat.

**Lack of maintenance or improper maintenance will trigger the loss of control of the boat when sailing and consequently can lead to personal injury or death of crew members.**

## 8.3. Field of vision from helm position

Helmsman of boat should be assured with the wide angle of sight from the main steering position.



### CAUTION

For safety reasons, a helmsman of a boat should pay particular attention to:

- ✓ weight of load and its location,
- ✓ speed,
- ✓ sudden acceleration,
- ✓ state of water area,
- ✓ weather conditions, such as: rain, drizzle, fog,
- ✓ lighting of a boat at dusk and night,
- ✓ people and moveable elements around the steering area.

## 9. FUEL SYSTEM

The boat is equipped with a portable fuel tank made of plastic with capacity of 30L, which is placed in the aft locker.

The fuel tank has a fuel gauge in his cap.

Every fuel of tank is made according to PN EN ISO 10088 and have sign CE.



### DANGER

#### Explosion and fire hazard

#### Never:

- ✓ smoke, or use open fire while fueling or when you work over the system fuel.
- ✓ use the open fire to check the tightness of fuel tank,
- ✓ keep the fuel or flammable substances in tightly closed compartment,
- ✓ cover the ventilating checks of compartment in which is the fuel tank. They should be still open, that vapours of fuel could not gather.



### WARNING

Check regularly the fuel installation – minimum twice a year.

When you notice, that the state of fuel installation get worse or damage you should immediately change affected elements.



### WARNING

When you detect the leakage of fuel close the fuel valve and repairs system before starting operation.

The fuel system should be repaired by the competent person system.



### CAUTION

#### Always

Follow to engine manufacturer instruction of service of engine

You guard against by errors and retain full rights to the guarantee.

## 10. ELECTRIC INSTALLATION

The boat is equipped with electric installation of direct current = 12V.  
 The main source of the boat is the battery with a capacity of 30 Ah to 72 Ah.  
 The battery is located in compartments.  
 Before cruise, check the battery level.



Photo shows the location for the battery including derived leads.



### CAUTION

Always:

- ✓ check the battery and level of charging before sailing,
- ✓ take battery off from a boat before winter season or before long time when boat will not be exploited.

Voltage from battery is distributed to other devices through switchboards placed on the console helmsman.

Each current receiver is described on a switchboard.

1. bilge pump - manual function (work when press and hold the button, when you let go of it stops working),
2. bilge pump - automatic function (after pressing the pump is still active),
3. the top white lamp - lighting navigation,
4. lamps red and green - lighting navigation,
5. lamps on the board.



### CAUTION

Never:

- ✓ work on the live electric installation,
- ✓ modify the craft's electric system or relevant schemes; any modifications and maintenance should be performed by a qualified marine electric technician,
- ✓ leave the boat unattended with the working electric system.



**CAUTION**

Remember, before starting work, turn off the main power switch!

Main power switch.



**Scheme of electric installation\***

\*) Scheme of electric installation depends on the equipment ordered by customer.

**Electrical installation diagram (simplified)**  
 Corsiva 475 New Age, Corsiva 520 Classic, Corsiva 565 New Age,  
 Corsiva 570 Classic, Corsiva 590 Tender, Corsiva 595 Tender

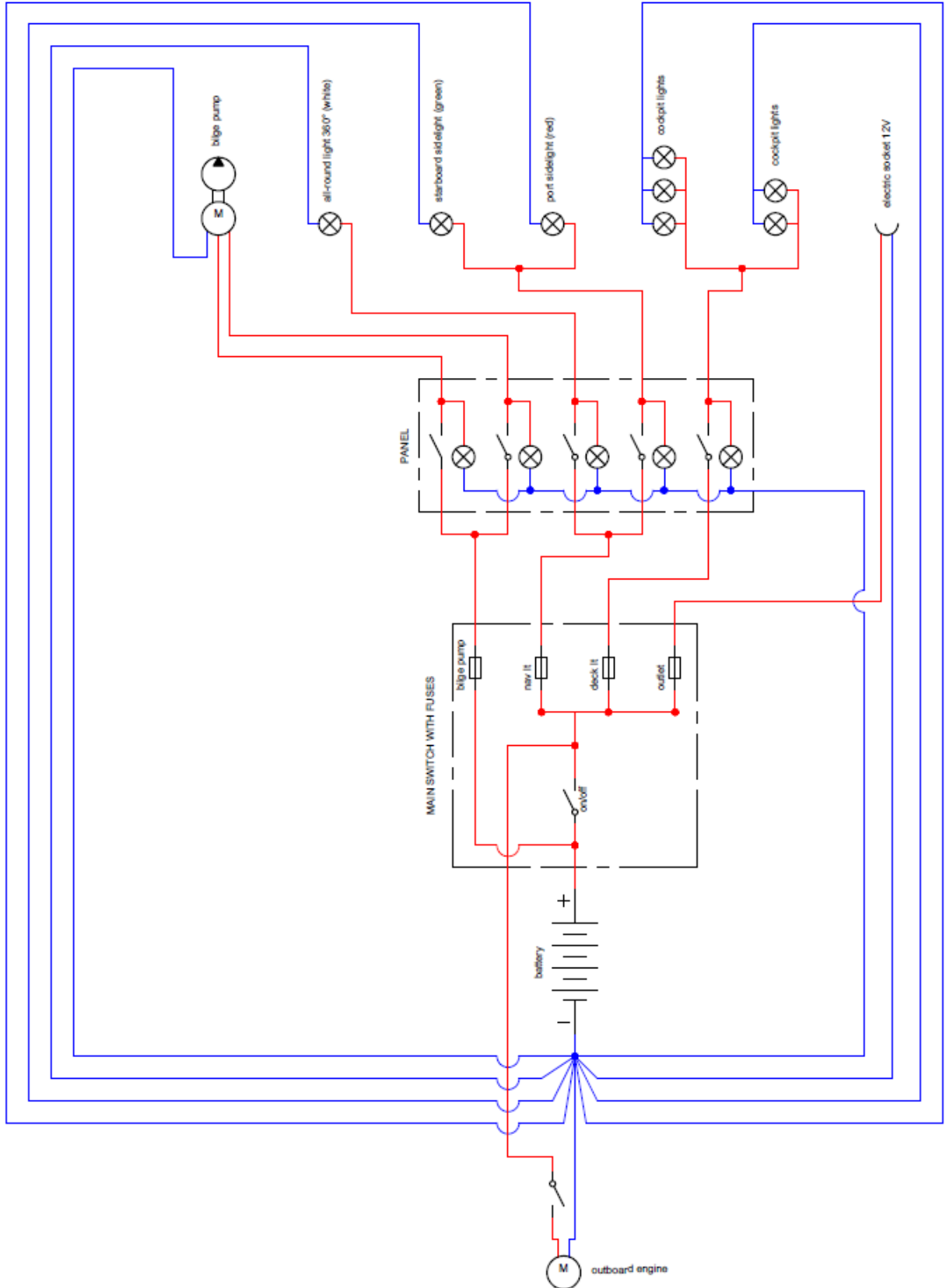

## 11. SANITARY SYSTEM

On the boat is provided a chemical toilet in bow compartment.

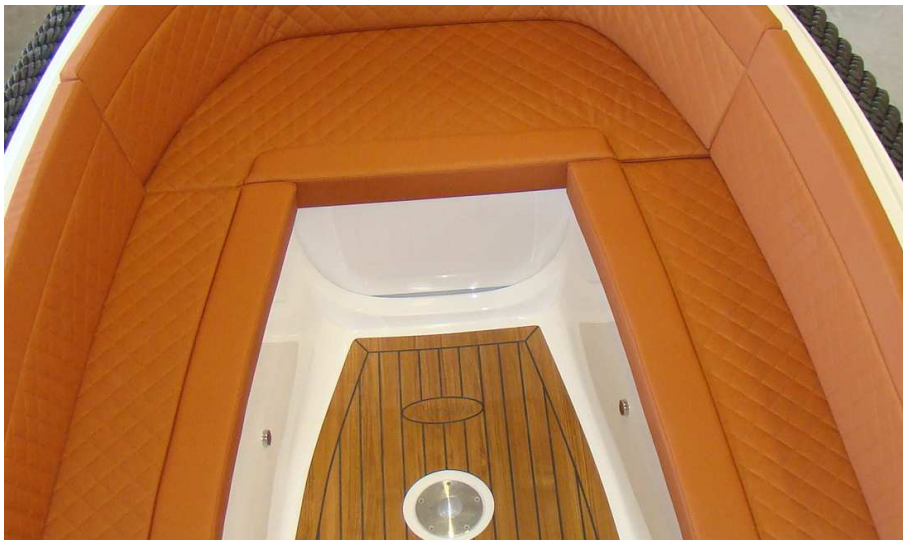

The rules of its use and maintenance are described in the manual book of WC manufacturer



### CAUTION

Before using the toilet make sure it is open water intake valve.



### CAUTION

While using WC **you should not:**

- ✓ throw rags, dressings and hard objects into WC,
- ✓ overflow the waste tank.

Tank waste should be emptied at the agreed appointed places (harbors).

## 12. BILGE INSTALATION

The bilge system is installed in the galley under the floor.

Bilge pump suction nozzle



Hand bilge pump under the deck



Consists of

1. Bilge pump suction nozzle,
2. Bilge houses,
3. Bilge pump outlet.

On the boat is equipped with two automatic bilge pumps and one manual bilge pump.

Automatic bilge pumps can work automatically after power-up the float switch (which is location near sucking pump basket) or by hand operating from the switch panel if it is necessary.



### DANGER

Installed bilge installation is not intended to dry the damaged yacht .



### WARNING

Before each season check the state of connections and the tightness of bilge installation.

Check in regularly the work of the bilge pump.

Regularly remove dirt from inlet of sucking bilge pump basket.

Never use the flammable solvents to cleaning of bilge.



### CAUTION

Do not discharge oily water overboard, in moment when boat is afloat.







### CAUTION

It is recommended to have the bucket on boat which you can use in sudden cases.



### 13. BOTTOM, SIDE SEA OPENINGS

The openings in deck, bottom and side may pose a danger as water can get into the boat.  
Sea valves are served manually, therefore they should be controlled.

1	<p>The outflow from anchor locker to broadside</p> 
2	<p>The outflow from cup holder to outlet in engine compartment</p> 
3,4	<p>The outflow from cockpit to bilge</p> 
4	<p>The outflow from bilge to outlet in engine compartment by an automatic bilge pump</p> 
5	<p>The outflow from bilge to outlet in engine compartment by a manual bilge pump</p> 

**DANGER****Never:**

- ✓ leave the unattended yacht with open valves,
- ✓ change the construction of valves connection.

## 14. FIRE PROTECTION

The main source of fire on the boat is open fire such as a lighter or candle.

**WARNING**

Before using you should:

- ✓ get to know with manufacturer's instruction in detail
- ✓ equip the boat with fire extinguisher and extinguishing blanket,
- ✓ pay attention to the usage of evacuation exits.

**CAUTION**

The owner/helmsman should:

- ✓ check the extinguishing equipment periodically according to requirements written on the equipment.
- ✓ replace the fire extinguishers after their expiration date or when they are used.

On your boat is a designated place to store fire extinguisher on the wall of the steering column.

## 15. SUNDECK

According with customer's wish the boat of superstructure can stand the place to sunbathing for crew.



You should turn the special attention on behaviors of principles of safety and proper care of mattresses.



### DANGER

Forbidding of transport the children's less 5 years old on stern sundeck and juvenile without lifejackets and parents or the guardians control.

#### Never

- ✓ not come in on the stern sundeck, when boat is moving,
- ✓ not stand up on stern and bow sundeck, when boat is moving.

#### Always

- ✓ should lie or sit on sundecks, when boat is moving,
- ✓ should hold rails on during maneuvers of boat.



### DANGER

The maximum speed where people are on the sun deck is 15 km / h and max. 0.5 m height wave.

To keep mattresses in good state you should clean it only with warmth water and gentle centers. Don't soak mattresses and after cleaning you should dry it because of mould.



### CAUTION

Domestic and industrial cleaning agents should be applied in reasonable amounts, because they can damage or discolor mattresses. Cleaning of agents on dry and solvents use very carefully.

### 15.1. Upholstery

The upholstery should be installed according to the scheme as pictured.

Each pillow mattresses has its own designation - it will help you to replacement of individual cushions, when it will be destroyed.

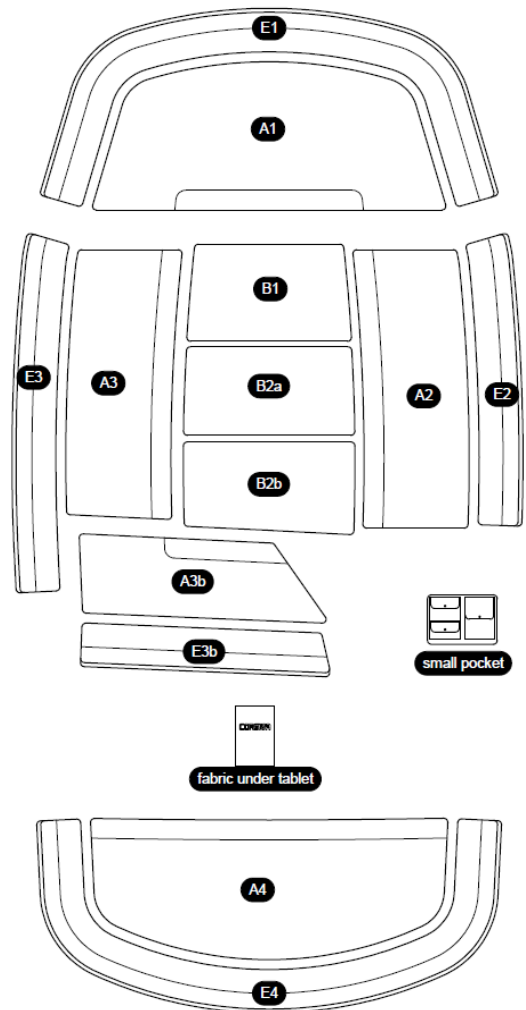

Upholstery marked with the letter E - backrest  
 Upholstery marked with the letter A - Seat  
 Upholstery marked with the letter B - sun deck  
 And for that there is a small pocket.

#### Maintenance

Upholstered elements will be protected well enough through regular cleaning with a solution of tepid water and gentle detergents or car vinyl cleaning agents. After they have been cleaned, they should be washed and dried so as to avoid molding. Upholstered elements should be dried and covered with anti-molding spray.



#### **CAUTION**

Some car, domestic or industrial cleaning agents can cause damages or change of color of upholstered elements. Solvents and cleaning agents for dry cleaning, containing dyes or wax or paraffin wax, should be used carefully. Any stains should be removed immediately. If they are left for some time, they may become hard to remove.

## 16. MAINTENANCE, PAINTING, CLEANING

Your boat – the deck, hull and some interior parts were made of fiberglass.

To keep the boat in good condition, wash the fiberglass regularly. Wash the boat with clean water with soft detergents, e.g. water with soap.

**Do not** use abrasive cleaning, solvents, ammonia, chlorine or acetone as these will damage the gel-coat surface.

In extreme cases, special cleaners may be used to remove sea growth or algae from the hull. Growths and algae can worsen the efficiency of the boat.

**Do not use wire brushes, abrasive paper or paste to remove growths and algae. The arisen scratches may store dirt, growth and algae.**

The hull bottom should be painted with anti-fouling.

Before painting the boat, please consult with the manufacturer which paint is the best.



### WARNING

Cleaning or washing with solvents can cause the fire, explosion and health problems. Always wear necessary protective clothing while cleaning (gloves, goggles, protective mask).



### CAUTION

Get acquainted with safety code of environment protection before painting the boat. Get acquainted with suggestions and instructions of using products before you start using them. Follow the instructions of the paints' and varnishes' manufacturer. Consult the local authorities to learn the current regulations concerning environmental protection.



### UWAGA

To maintain the warranty on the hull of the boat should be serviced every year and the hull to protect antifouling.

### 16.1. Stainless steel

Constructions of bow and stern railings, as well as other metal elements were made of corrosion resistant steel, which means polished stainless steel.



#### WARNIG

If you want to keep stainless steel fitting in good state,  
**you should:**

- ✓ clean all fittings only with soap and water,
- ✓ use a good quality car wax to protect the stainless steel,
- ✓ wash the deck fitting with sweet water and clean from salt deposits after each sailing on salt water,
- ✓ check the fittings regularly, especially frequently if you sail on salt water and high level of humidity and temperature.

**you should not:**

- ✓ use abrasive materials or acids



#### CAUTION

The guarantee does not include the slight rust spots caused by lack of or inappropriate maintenance of stainless steel fitting.

## 17. TRAILERING

During the boat transportation it is very important to keep the boat in the horizontal position. Lifting belts should be in the places appointed with the red triangle on a hull according to the following drawing.

However, depending on the equipment of the boat, lifting places may change about several centimeters to stern or bow.

To control hull movements during lifting should fasten to bow and stern cleats lines, which make possible direct the boat in moment, when it is in air.

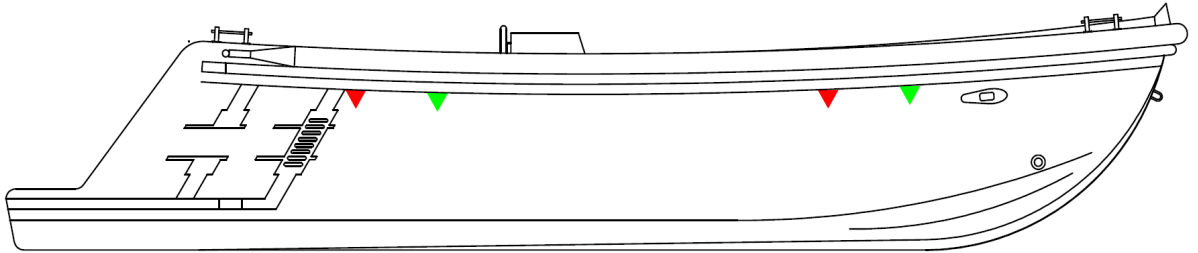

Red triangles marked places where you should put the lifting belts with engine.



Green triangles marked places where you should put the lifting belts without engine.



### WARNING

People presence under lifted or in boat neighborhood is strongly prohibited.

During placement the hull on trailer one should pay attention that axis of symmetry of hull will be the same like trailer, because trailer rollers are the same support of boat.

Take care that the supports will be in places of fences boat.

Bow should be placed in limiter of movement tightly and provide for across fastening to the tow ear placed on bow of boat.

Boat to trailer should be fastened whit pulling off belts.

### Traverse raising.

Traverse regulates the lifting straps, to be in a certain spacing and not clutching a hull boat's at lifting time.

Another solution could damage the hull of boat.

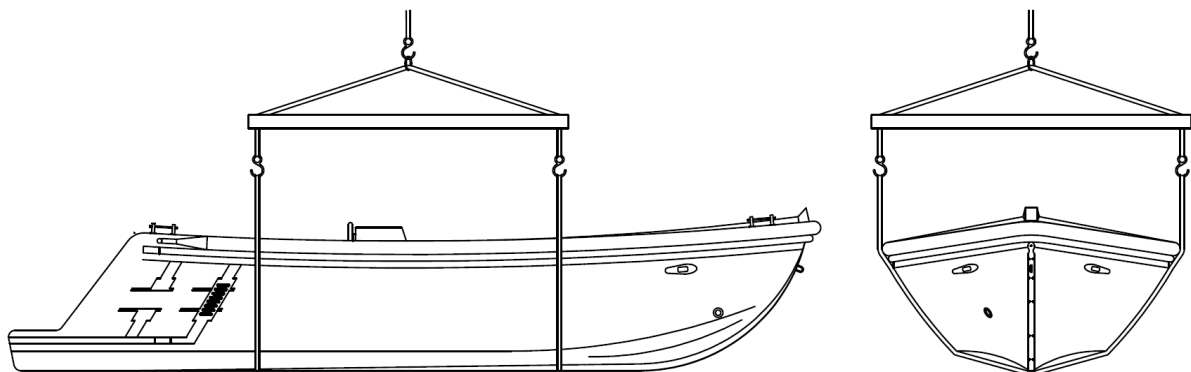

## 18. ANCHORING, MOORING AND TOWING

The owner of a boat / helmsman is responsible for equipping the boat with an anchor, anchor chain / anchor rope, mooring and towing lines ready to use.

### Anchorahe equipment

Place the anchor in the anchor compartment. Anchor rope is secured to the cleats.

Recommended equipment

anchor: 7-8 kg

	Material	Diameter	Length
Anchor rope	poliamid	10mm	25-30m



### CAUTION

Before going on a cruise every helmsman should check if there is an appropriate anchor with a rope or chain. You have to pay attention to have an anchor with rope always ready to use.

### Mooring equipment

Be careful so the mooring ropes would not tangle in propeller or around rudder.

Recommended equipment:

	Material	Diameter	Length
Mooring rope	poliamid	10mm	2 × 15m

### Towing equipment

Before towing, fasten the towing rope to both mooring cleats on a bow. Other places on the boat are improper to fastening the towing rope.

The anchor rope can replace the towing rope, but it is recommended to have a special rope, with the same diameter, designed for towing.

Recommended equipment:

	Material	Diameter	Length
Towing rope	poliamid	10mm	25-30m



### CAUTION

The towing speed should be less than theoretical speed of the hull in order to prevent towing forces from damaging the boat.



## 19. ENVIRONMENTAL PROTECTION

The chapter contains the indispensable information how you should protect the natural environment during sailing, as well from the crew as from the boat side.

There are strict requirements concerning the respect of natural environment not only in many parts of Europe but also all over the world.

The owner is responsible for the knowledge of valid requirements on the particular water area and for obeying them.

### 19.1. Oil derivatives

The leakages of fuel or oil pollutes the environment and poses a danger to wildlife.



#### WARNING

Never pour fuel or oil out to water.  
It is prohibited and you can be fined for that



#### CAUTION

Treat any oils / oil derivatives as chemical waste.

#### Always

In case of oil leakage, try to recognize its source as fastest as possible.  
Remove oil derivatives wastes (used oils) in a proper way.

#### Never

Overflow fuel tank during its fueling. All the works concerning the repair of an engine should be performed on land.  
Throw dirty bilge water overboard.  
Store any rags to wipe oil derivatives or chemical substances.  
After using a rag, remove it on land according to valid regulations.

### 19.2. Sewage and waste removal

Removing sewages into navigation waters is strictly prohibited among many water areas.

The user of the boat is required to know all the valid local rights concerning the removal of liquid sewages into navigation waters.

Sewage removal should take place in appointed places on land.

Waste should be kept in small durable bags and throw out in appointed places on land.

**WARNING**

If the bilge water are dirty avoid the the work of automatic bilge pump, do not remove the illegal plants.  
Do not remove the contaminated bilge water overboard.

**WARNING**

In case if you lack the place for storing waste on the boat, you can remove only organic waste to water.

## 20. REMOVING FAILURES

Do not make repairs alone, unless you are authorized; get only professional advice and information. Use only certified materials and replaceable parts.

**WARNING**

Do not interfere in the construction of the boat nor install any additional equipment or change anything in the boat construction.

Changes may be carried out only after consulting the boat manufacturer and obtaining his consent in writing.

If an owner makes changes to boat construction or equipment without the manufacturer's consent, it will cause the guarantee loss.

An owner takes responsibility for any consequences of changes made by himself.

## 21. WARRANTY

Each of customer is obliged to read terms of warranty and sign an appropriate statement on the understanding and acceptance of these conditions. The statement should be in duplicate: for the customer and the boat seller.

1. Manufacturer CORSIVA YACHTING Artur Grugel with headquarters in Ciechocin it gives guarantee on motor boat **CORSIVA 595 TENDER** number CIN:

P	L	-	C	O	R										
---	---	---	---	---	---	--	--	--	--	--	--	--	--	--	--

- 3 years for customers using the boat for personal use only on the hull structure, eg. no laminate cracks, no delamination of the laminate, no blisters on the laminate, the guarantee does not enclose mechanical damage,
  - 12 months for customers using the boat commercially for income targets i.e. rentals, yacht charters e.t.c., on the hull structure, eg. no laminate cracks, no delamination of the laminate, no blisters on the laminate, the guarantee does not enclose mechanical damage,
  - 2 years for all customers against osmosis laminate, which haven't an additional anti-osmotic protection (after two years necessary is use anti-osmotic protection, in another way the complaint won't be taken into account),
  - 2 years for customers using the boat for personal use only on pieces of equipment installed in the yard,
  - 12 months for customers using the boat commercially for income targets i.e. rentals, yacht charters e.t.c. on pieces of equipment installed in the yard,
  - 12 months for all customers on non-structural elements. In the case of wooden elements, follow the Owner's Manual your boat.
2. The boat must be used in accordance with the conditions specified on CE plate.
  3. The guarantee periods starts on the day of delivery of boat/ exposure of invoice. Invoice is the basis for warranty claims.
  4. A physical defect means a defect diminishing the value of the equipment or its usefulness, which makes it impossible to exploit the equipment in accordance with its appropriation.  
 Guarantee repair shall not include actions specified in the *Owner's manual*, which should be undertaken by the equipment user on his own and at his expense. The Guarantor shall choose the method of defect elimination; he may decide to repair the equipment through repair or replacement of damaged part or may replace all the equipment.

5. The condition for the complaint to be accepted during the guarantee period is delivery or presentation of the equipment together with a duly completed Invoice card (i.e. containing identification number of the equipment, date of sale, corporate seal of the Seller, signature of the person issuing the invoice and signature of the Buyer).
6. The boat and drive motor installed on it should be on separate invoices, due to different warranty conditions.
7. The Guarantee shall not cover accidents occurred during transportation and handling or damages caused by such actions.
8. CORSIVA YACHTING Arthur Grugel undertakes to make necessary repairs as quickly as possible, legally regulated deadline.
9. Guarantee period becomes prolonged about time of possible guarantee repairs.
10. CORSIVA YACHTING Arthur Grugel it does not bear no responsibility for possible financial losses or different legal after-effect, caused pronouncement defect in complaint boat.
11. Warranty does not include materials and maintenance, belonging to the normal operational service, eg. cleaning, maintenance, inspection, etc.
12. These warranties only include damage and defects resulting from causes inherent in the sold boat.  
Warranty does not include damage caused as a result of external factors, such as, for example. Mechanical damage, damage caused by meteorological phenomena, phenomena electrolysis (particularly as a result berth in the marina of faulty installation 220V), pollution, flooding, fire, caused by using the wrong consumables (eg. aggressive cleaning agents, improper oils, lubricants, etc.), misuse, unauthorized repairs or alterations, improper securing the boat before winter.
13. The manufacturer is not responsibility under the warranty in case of:
  - arbitrarily installed by the customer in the boat equipment or accessories that may have a significant impact on the properties of the boat,
  - damage to the hull and deck made as a result of carried out unauthorized construction changes
  - improper use and maintenance of the boat, omissions or improper servicing your boat.
  - operational processes of the hull, equipment and accessories associated with normal use and about using a boat during the warranty period,
  - mechanical and chemical damage of boat which are a result of the collision, scratches and other mechanical and chemical damage.
14. A boat which is repaired or remaking the unauthorized by the shipyard CORSIVA YACHTING Arthur Grugel way, you lose any guarantees.

15. This warranty does not including:
  - boats used for sporting competitive sports,
  - discoloration: glass, gel coat, paint, hardware, stainless steel, as they are a normal phenomenon that occurs during normal operation and under the influence of meteorological phenomena.
  
16. In matters not regulated by the provisions of the relevant provisions of the Civil Code.

Records warranty.

Date of raising the claim	Note about repair	Date of realization the repair	Guarantee was prolonged	Date, signature and stamp